

look vasche sottopiano _undercounter bathtubs_bañeras bajo encimera

- vasche sottopiano in diverse finiture e tipologie.
- sifone.
- piletta con troppo pieno.
- erogazione da bordo vasca.
- top.
- rivestimenti laterali.
- idromassaggio base/pro.
- cromoterapia base/pro.

- opzionale
- opzionale
- opzionale
- opzionale
- opzionale

- undercounter tubs in various finishes and types.
- siphon.
- waste with overflow.
- dispensing from bathtub edge.
- top.
- side panelling.
- base/pro hydromassage.
- base/pro colour therapy.

- optional
- optional
- optional
- optional
- optional

- bañeras encastradas en el suelo de distintos tipos y acabados.
- sifón.
- válvula de desagüe con rebosadero.
- suministro desde el borde de la bañera.
- encimera.
- revestimientos laterales.
- hidromasaje base/pro.
- cromoterapia base/pro.

- opcional
- opcional
- opcional
- opcional
- opcional



square

180x80
square

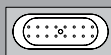

circle

180x80
ang DX

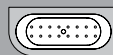

180x80
ang SX

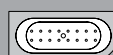

180x80
parete

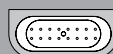

180x80
isola

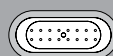

180x80
penisola

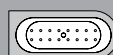

plus

180x90
ang DX

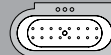

180x90
ang SX

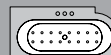

180x90
parete

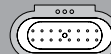

city

150x150
angolo

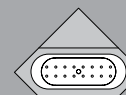

look
square

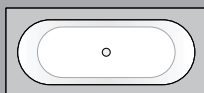

look
+ idrolook

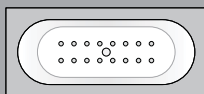

look
+ idrolook
+ colorlook

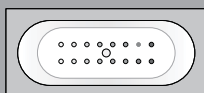

look vasche sottopiano _undercounter bathtubs_ bañeras bajo encimera

look e idrolook sono costituite da elementi strutturali in pse accoppiati con innesti di fissaggio e da un bacino in acrilico di alta qualità.

look and idrolook are made of EPS structural elements coupled with fastening connections and a high-quality acrylic basin.

look e idrolook están constituidas por elementos estructurales de EPS acoplados con empalmes de fijación y una pila de acrílico de alta calidad.

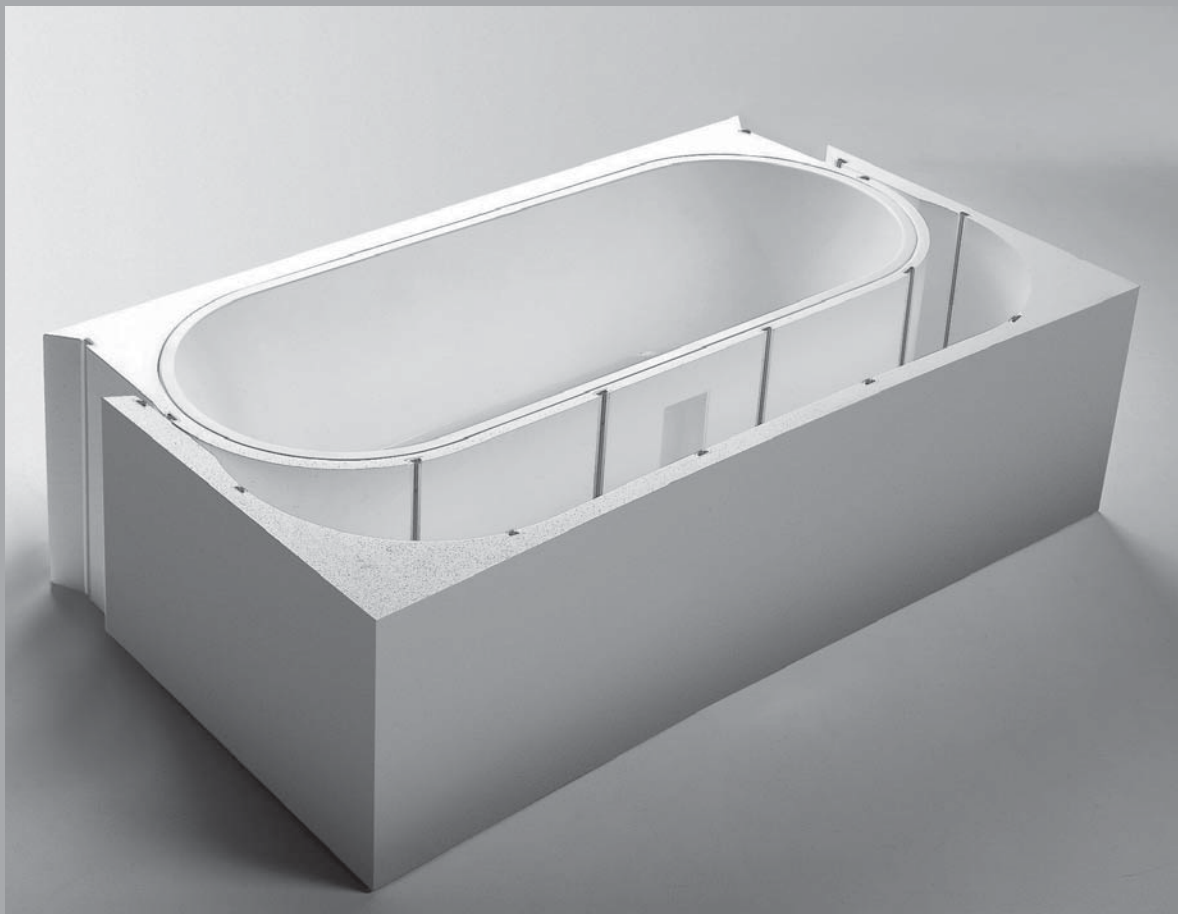

look



idrolook

look vasche sottopiano _undercounter bathtubs_bañeras bajo encimera

idro-look system

Sistema di distribuzione e diffusione integrato a doppia camera, con air-ject a iniezione diretta.

Double chamber integrated distribution and diffusion system, with air-ject direct injection.

Sistema de distribución y difusión integrado de doble cámara, con jet de aire de inyección directa.



color-look system

Sistema cromoterapico a led luminosi ad alta efficienza. diffusione della luce attraverso 16 air-jects integrati.

Colour therapy system with high-efficiency luminous LED's light diffusion through 16 integral air-jects.

Sistema cromoterápico con led luminosi de alta eficiencia. Difusión de la luz a través de 16 jets de aire integrados.

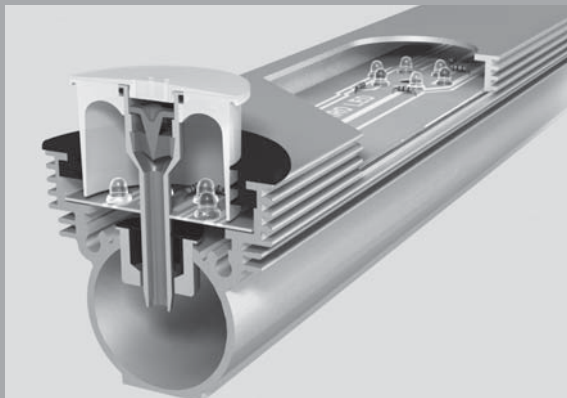

water-drain system

Sistema di drenaggio di eventuale condensa all'interno della camera di distribuzione.

System for drainage of possible condensation in distribution chamber.

Sistema de drenaje del posible vapor de condensación presente en el interior de la cámara de distribución.



mk24 blower

Blower ad elevato rendimento, alimentata a 24V, con potenza di 240W. Centralina e trasformatore inseriti su slitta mobile per ispezione.

High-performance blower powered at 24V, with power of 240W. Control unit and transformer inserted on slides for inspection.

Blower de elevado rendimiento, con alimentación 24V y potencia 240W. Circuito de control y transformador incorporados en corredera móvil para permitir su inspección.



look

tipologie _ types _ tipos

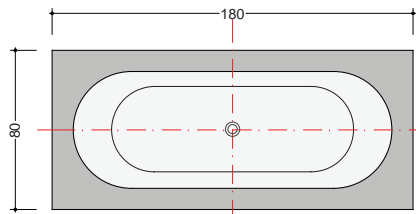

square
180x80

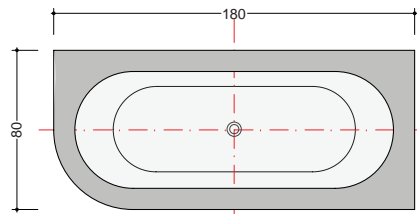

circle ang dx
160x80

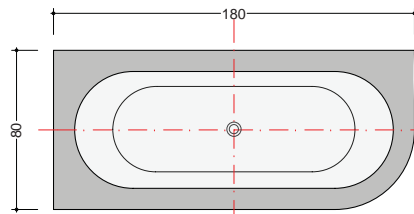

circle ang sx
160x80

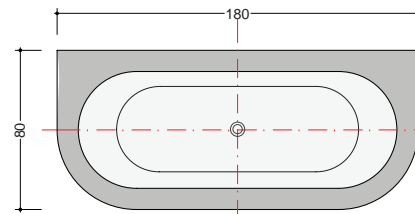

circle parete
160x80

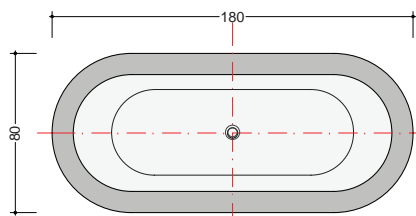

circle isola
160x80

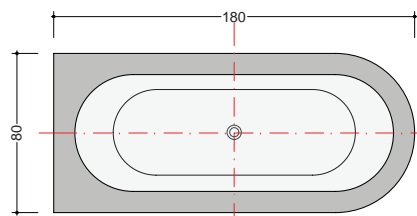

circle penisola
160x80

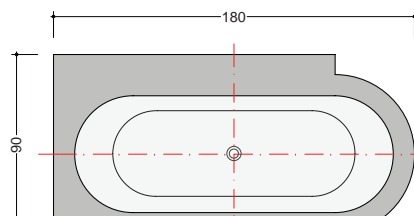

circle plus ang sx
160x80

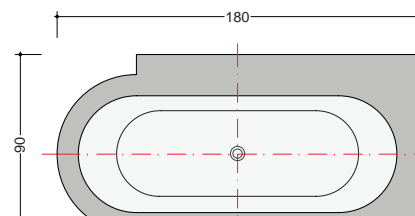

circle plus ang dx
160x80

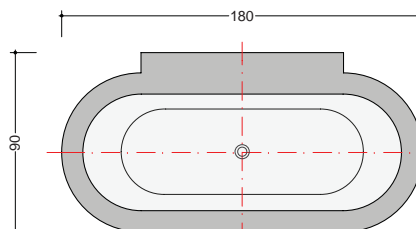

circle pus parete
160x80

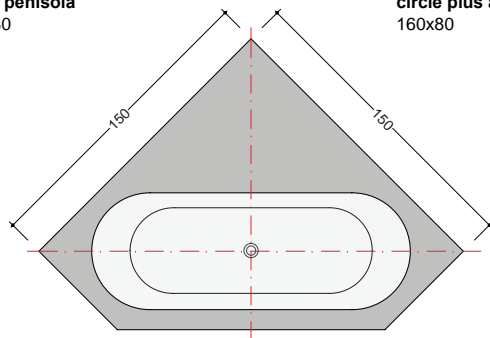

city
160x80

dati tecnici:

- **bacino in acrilico colato** spessore 4mm
- **capacità interna:** 160 lt
- **corpo in EPS** densità: 30 daN/mc
- **modello idrolook:** motore di serie a destra
- **tensione di rete:** 220
- **tensione soffiante:** 24V
- **potenza soffiante:** 220W
- **potenza cromoterapia:** 40W

technical data:

- **basin in cast acrylic,** thickness 4mm
- **internal capacity:** 160 lt
- **body in EPS,** density: 30 daN/mc
- **idrolook model:** motor standard on right
- **mains voltage:** 220
- **blower voltage:** 24V
- **blower power:** 220W
- **colour therapy power:** 40W

datos técnicos:

- **pila de acrílico colado de 4 mm de espesor**
- **capacidad interna:** 160 l
- **cuerpo de EPS densidad:** 30 daN/mc
- **modelo idrolook:** motor de serie a la derecha
- **tensión de red:** 220
- **tensión soplante:** 24V
- **potencia soplante:** 220W
- **potencia cromoterapia:** 40W

look

vasche sottopiano _undercounter bathtubs_bañeras bajo encimera

- 1_ bacino in acrilico colato / cast acrylic basin / pila de acrilico colado
- 2_ nucleo vasca in polistirene espanso / expanded polystyrene tub body / cuerpo bañera de poliestireno expandido (EPS)
- 3_ pannello esterno in pse / external polystyrene panel (EPS) / panel externo de poliestireno expandido (EPS)
- 4_ rivestimento / panelling / revestimiento
- 5_ top / top / encimera
- 6_ massetto ribassato per allacciamenti / lowered floor slab for connections / bloque rebajado para conexiones
- 7_ eventuale allacciamento erogazione bordo vasca / possibility to connect to deck-mounted tapware / posible conexión suministro borde bañera
- 8_ allacciamento alla rete di scarico / connection to drain system / conexión a la red de desagüe
- 9_ sifone Ø 40mm / siphon Ø 40mm / sifón Ø 40mm
- 10_ piletta con troppo pieno / waste with overflow / válvula de desagüe con rebosadero
- 11_ camera di pressurizzazione / pressurized chamber / cámara de presurización
- 12_ diffusori / air jets/ difusores
- 13_ cavo alimentazione / electrical cable / cable de alimentación
- 14_ pompa / pump / bomba
- 15_ centralina / control unit / circuito de contro
- 16_ slitta estraibile / removable slide / corredera extraíble
- 17_ dima / template / escantillón
- 18_ guida con innesto di fissaggio/ guide with fastening connector / guía con empalme de fijación

dati tecnici:

- **bacino in acrilico colato** spessore 4mm
- **capacità interna:** 160 lt
- **corpo in EPS** densità: 30 daN/mc
- **modello idrolook:** motore di serie a destra
- **tensione di rete:** 220
- **tensione soffiante:** 24V
- **potenza soffiante:** 220W
- **potenza cromoterapia:** 40W

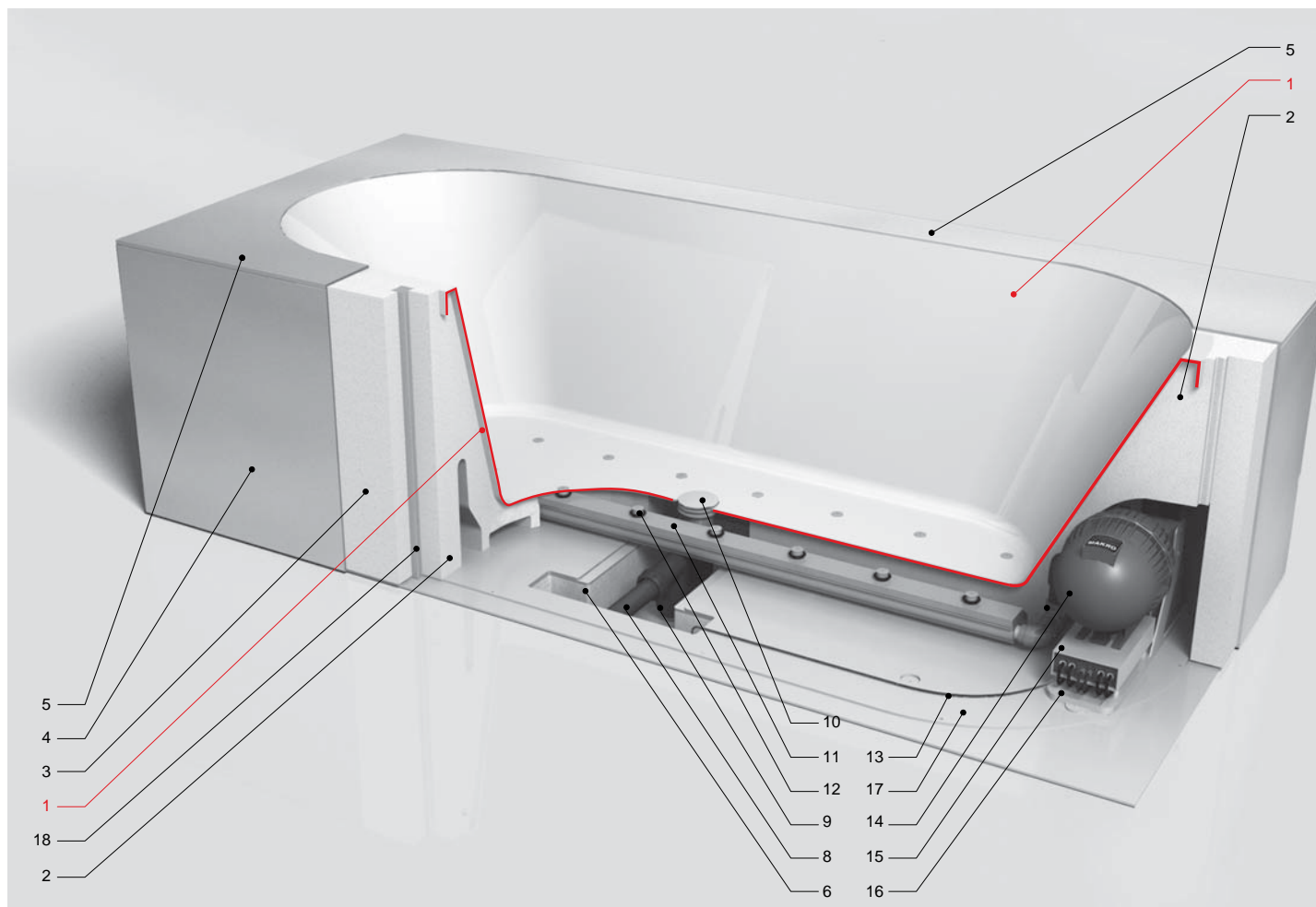

technical data:

- **basin in cast acrylic** thickness 4mm
- **internal capacity:** 160 lt
- **body in EPS, density:** 30 daN/mc
- **idrolook model:** motor standard on right
- **mains voltage:** 220
- **blower voltage:** 24V
- **blower power:** 220W
- **colour therapy power:** 40W

datos técnicos:

- **pila de acrilico colado** de 4 mm de espesor
- **capacidad interna:** 160 lt
- **corpo in EPS, densità:** 30 daN/mc
- **modelo idrolook:** motor de serie a la derecha
- **tensión de red:** 220
- **tensión sopiante:** 24V
- **potencia sopiante:** 220W
- **potencia cromoterapia:** 40W

look square 180x80 _

**rivestita / non rivestita
panelled / unclad
revestida / no revestida
verkleidet / unverkleidet**

idrolook

colorlook

**scheda tecnica
technical datashett
tarjeta técnica
technisches Datenblatt**

L.SQ_180.080_ / L.SQ_180.080.00

L.IDB.000.000.00

L.CLB.000.000.00

dati tecnici

- bacino in acrilico colato sp.4mm
 - corpo in EPS densità: 30 da N/mc
 - capacità interna: 160 lt
 - rivestimento laterale makro sp.: 6mm
 - idrolook: motore di serie a destra
 - tensione di rete: 220V
 - tensione soffiante: 24V
 - potenza soffiante 220W
 - potenza cromoterapia: 40W
- 1_ bacino in acrilico colato
 - 2_ struttura in polistirene espanso (PSE)
 - 3_ pannello esterno in pse
 - 4_ rivestimento laterale
 - 5_ top
 - 6_ colonna di scarico (lunghezza cavo 57,5 cm)
 - 7_ eventuale allacciamento da troppo pieno (ETP)
 - 8_ sifone Ø 40 mm
 - 9_ massetto ribassato per allacciamenti H.90 mm

technical information

- basin in cast acrylic thk. 4mm
 - body in EPS density: 30 da N/mc
 - internal capacity: 160 lt
 - pannelling makro thk. 6mm
 - idrolook: motor standard on right
 - mains voltage: 220V
 - blower voltage: 24V
 - blower power: 220W
 - colour therapy: 40W
- 1_ basin in cast acrylic
 - 2_ expanded polystyrene structure (EPS)
 - 3_ external polystyrene panel
 - 4_ pannelling
 - 5_ top
 - 6_ drain column (cable length 1.57,5 cm)
 - 7_ possibility to connect to deck-mounted tapware
 - 8_ siphon Ø 40 mm
 - 9_ lowered floor slab for connections H.90 mm

datos técnicos

- pila de acrilico colado de 4 mm de espesor
 - cuerpo de EPS densidad 30 N/mc
 - capacidad interna: 160 lt
 - revestimiento sp.: 6mm
 - idrolook: motor de serie a la derecha
 - tensión de red: 220V
 - tensión soplante: 24V
 - potencia soplante: 220W
 - potencia cromoterapia: 40W
- 1_ pila de acrilico colado
 - 2_ estructura de polistireno densidad (EPS)
 - 3_ panel externo de polistireno expandido (EPS)
 - 4_ revestimiento
 - 5_ encimera
 - 6_ columna de desagüe (longitud cable 57,5 cm)
 - 7_ posible conexión suministro borde bañera
 - 8_ sifón Ø 40mm
 - 9_ bloque rebajado para conexiones H.90 mm

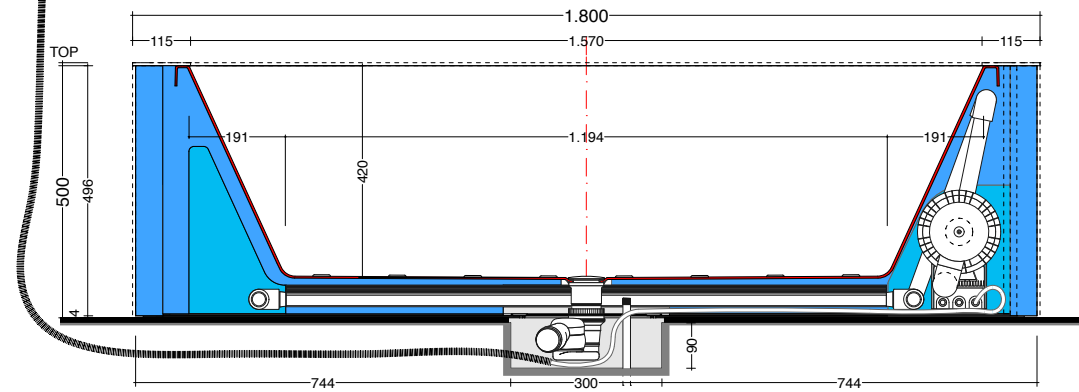
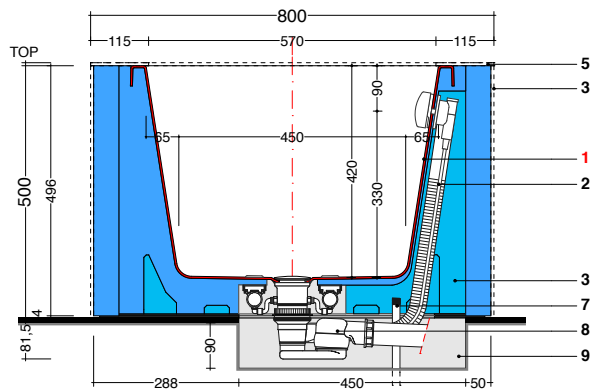
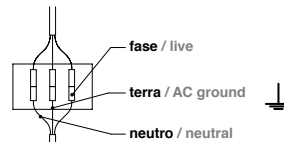
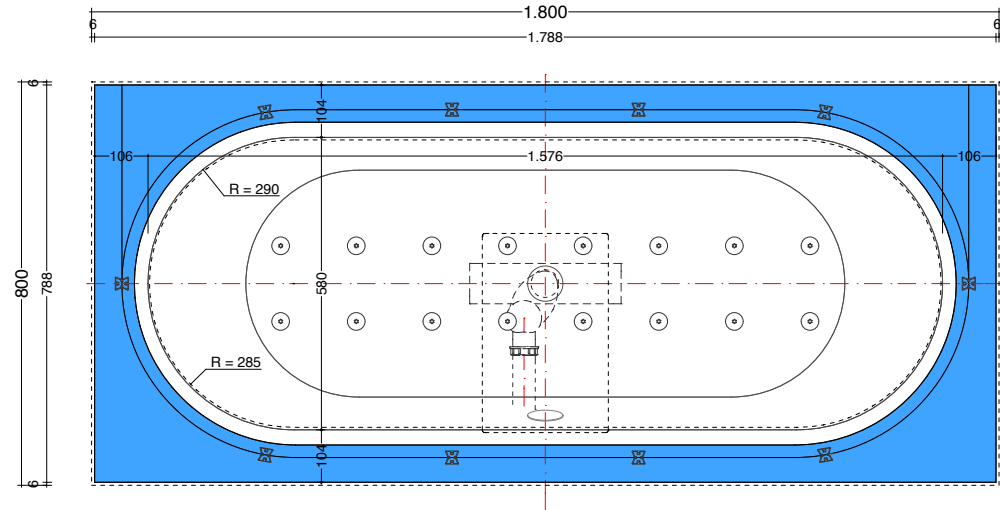

**look circle ang dx 180x80 _ rivestita / non rivestita
panelled / unclad
revestida / no revestida
verkleidet / unverkleidet**

idrolook

colorlook

scheda tecnica
technical datashett
tarjeta técnica
technisches Datenblatt

L.SQ_180.080_ / L.SQ_180.080.00

L.IDB.000.000.00

L.CLB.000.000.00

dati tecnici

- bacino in acrilico colato sp.4mm
 - corpo in EPS densità: 30 da N/mc
 - capacità interna: 160 lt
 - rivestimento laterale makro sp.: 6mm
 - idrolook: motore di serie a destra
 - tensione di rete: 220V
 - tensione soffiante: 24V
 - potenza soffiante 220W
 - potenza cromoterapia: 40W
- 1_ bacino in acrilico colato
 - 2_ struttura in polistirene espanso (PSE)
 - 3_ pannello esterno in pse
 - 4_ rivestimento laterale
 - 5_ top
 - 6_ colonna di scarico (lunghezza cavo 57,5 cm)
 - 7_ eventuale allacciamento da troppo pieno (ETP)
 - 8_ sifone Ø 40 mm
 - 9_ massetto ribassato per allacciamenti H.90 mm

technical information

- basin in cast acrylic thk. 4mm
 - body in EPS density: 30 da N/mc
 - internal capacity: 160 lt
 - panneling makro thk. 6mm
 - idrolook: motor standard on right
 - mains voltage: 220V
 - blower voltage: 24V
 - blower power: 220W
 - colour therapy: 40W
- 1_ basin in cast acrylic
 - 2_ expanded polystyrene structure (EPS)
 - 3_ external polystyrene panel
 - 4_ panneling
 - 5_ top
 - 6_ drain column (cable length 1.57,5 cm)
 - 7_ possibility to connect to deck-mounted tapware
 - 8_ siphon Ø 40 mm
 - 9_ lowered floor slab for connections H.90 mm

datos técnicos

- pila de acrilico colado de 4 mm de espesor
 - cuerpo de EPS densidad 30 N/mc
 - capacidad interna: 160 lt
 - revestimiento sp.: 6mm
 - idrolook: motor de serie a la derecha
 - tensión de red: 220V
 - tensión soplante: 24V
 - potencia soplante: 220W
 - potencia cromoterapia: 40W
- 1_ pila de acrilico colado
 - 2_ estructura de polistireno densidad (EPS)
 - 3_ panel externo de polistireno expandido (EPS)
 - 4_ revestimiento
 - 5_ encimera
 - 6_ columna de desagüe (longitud cable 57,5 cm)
 - 7_ posible conexión suministro borde bañera
 - 8_ sifón Ø 40mm
 - 9_ bloque rebajado para conexiones H.90 mm

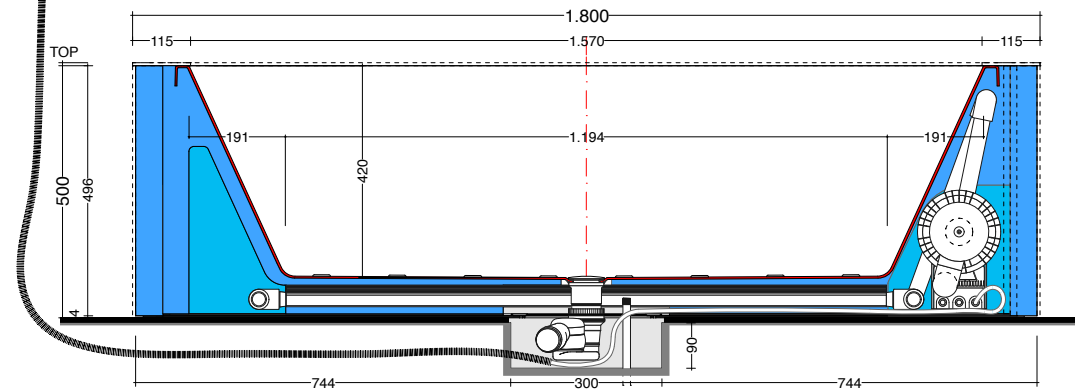
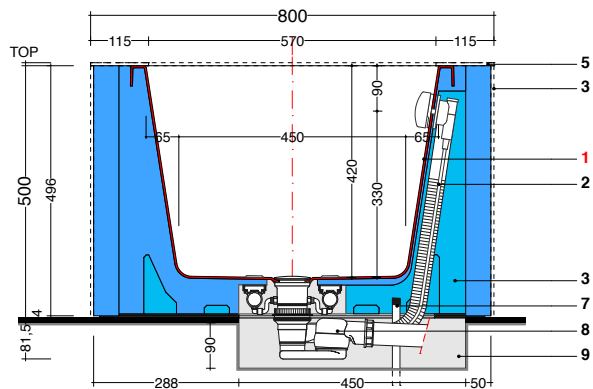
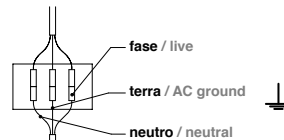
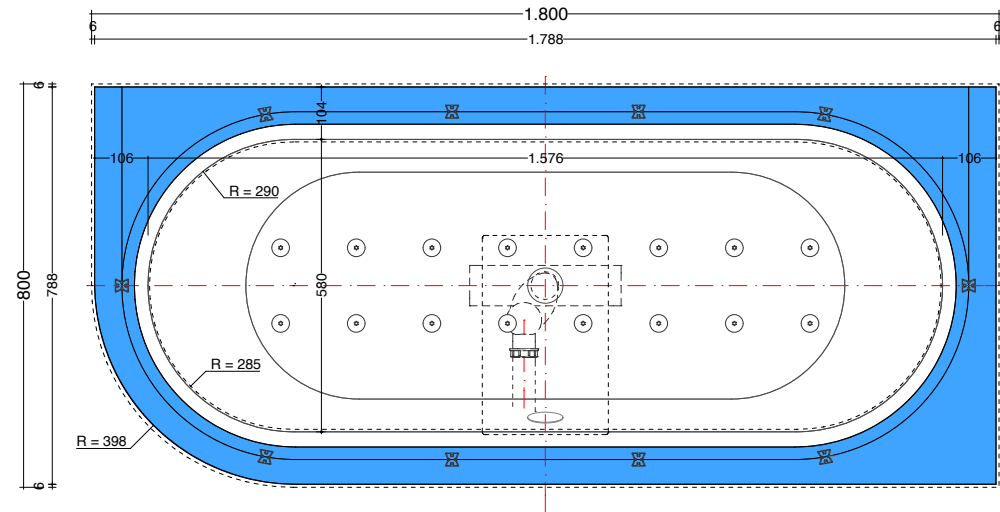

**look circle ang sx 180x80 _ rivestita / non rivestita
panelled / unclad
revestida / no revestida
verkleidet / unverkleidet**

idrolook

colorlook

**scheda tecnica
technical datashett
tarjeta técnica
technisches Datenblatt**

L.SQ_180.080_ / L.SQ_180.080.00

L.IDB.000.000.00

L.CLB.000.000.00

dati tecnici

- bacino in acrilico colato sp.4mm
 - corpo in EPS densità: 30 da N/mc
 - capacità interna: 160 lt
 - rivestimento laterale makro sp.: 6mm
 - idrolook: motore di serie a destra
 - tensione di rete: 220V
 - tensione soffiante: 24V
 - potenza soffiante 220W
 - potenza cromoterapia: 40W
- 1_ bacino in acrilico colato
 - 2_ struttura in polistirene espanso (PSE)
 - 3_ pannello esterno in pse
 - 4_ rivestimento laterale
 - 5_ top
 - 6_ colonna di scarico (lunghezza cavo 57,5 cm)
 - 7_ eventuale allacciamento da troppo pieno (ETP)
 - 8_ sifone Ø 40 mm
 - 9_ massetto ribassato per allacciamenti H.90 mm

technical information

- basin in cast acrylic thk. 4mm
 - body in EPS density: 30 da N/mc
 - internal capacity: 160 lt
 - pannelling makro thk. 6mm
 - idrolook: motor standard on right
 - mains voltage: 220V
 - blower voltage: 24V
 - blower power: 220W
 - colour therapy: 40W
- 1_ basin in cast acrylic
 - 2_ expanded polystyrene structure (EPS)
 - 3_ external polystyrene panel
 - 4_ pannelling
 - 5_ top
 - 6_ drain column (cable length 1.57,5 cm)
 - 7_ possibility to connect to deck-mounted tapware
 - 8_ siphon Ø 40 mm
 - 9_ lowered floor slab for connections H.90 mm

datos técnicos

- pila de acrilico colado de 4 mm de espesor
 - cuerpo de EPS densidad 30 N/mc
 - capacidad interna: 160 lt
 - revestimiento sp.: 6mm
 - idrolook: motor de serie a la derecha
 - tensión de red: 220V
 - tensión soplante: 24V
 - potencia soplante: 220W
 - potencia cromoterapia: 40W
- 1_ pila de acrilico colado
 - 2_ estructura de polistireno densidad (EPS)
 - 3_ panel externo de polistireno expandido (EPS)
 - 4_ revestimiento
 - 5_ encimera
 - 6_ columna de desagüe (longitud cable 57,5 cm)
 - 7_ posible conexión suministro borde bañera
 - 8_ sifón Ø 40mm
 - 9_ bloque rebajado para conexiones H.90 mm

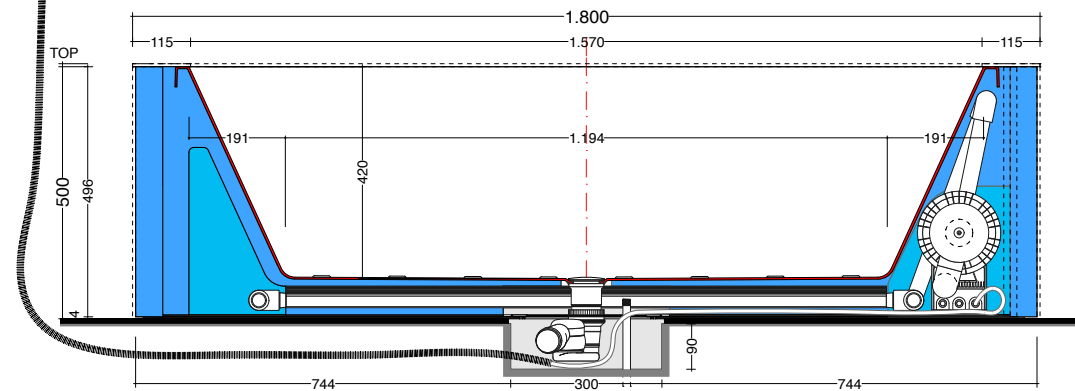
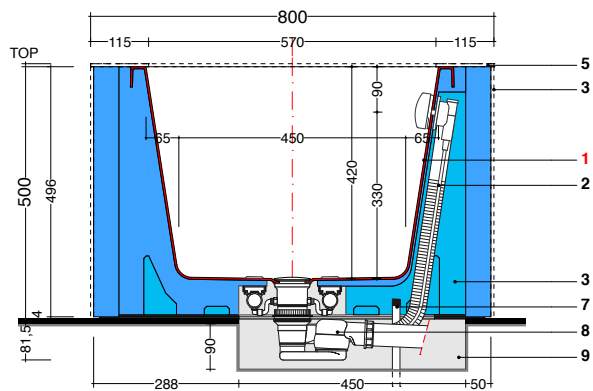
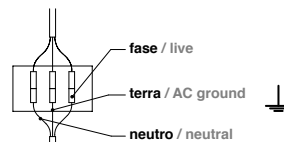
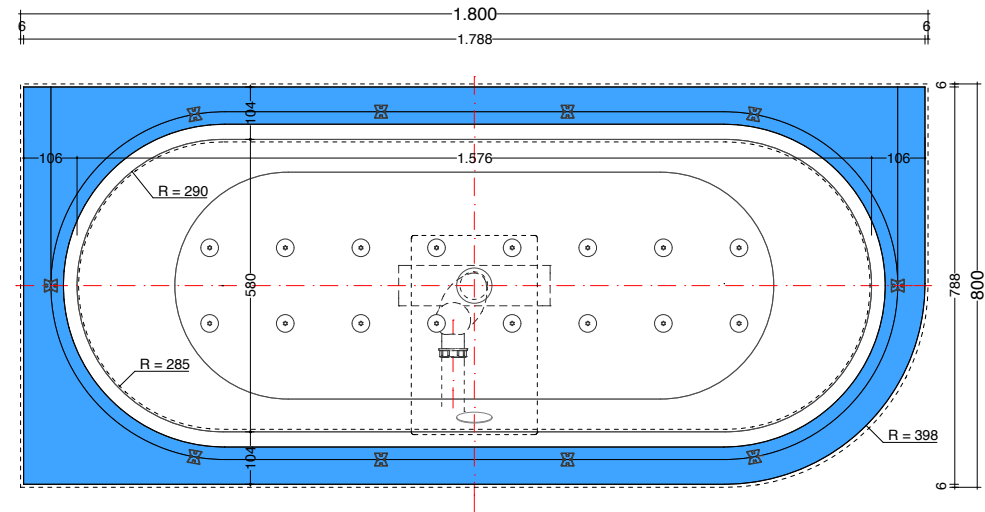

**look circle parete 180x80 _ rivestita / non rivestita
panelled / unclad
revestida / no revestida
verkleidet / unverkleidet**

idrolook

colorlook

scheda tecnica
technical datashett
tarjeta técnica
technisches Datenblatt

L.SQ_180.080_ / L.SQ_180.080.00

L.IDB.000.000.00

L.CLB.000.000.00

dati tecnici

- bacino in acrilico colato sp.4mm
- corpo in EPS densità: 30 da N/mc
- capacità interna: 160 lt
- rivestimento laterale makro sp.: 6mm
- idrolook: motore di serie a destra
- tensione di rete: 220V
- tensione soffiante: 24V
- potenza soffiante 220W
- potenza cromoterapia: 40W

- 1_ bacino in acrilico colato
- 2_ struttura in polistirene espanso (PSE)
- 3_ pannello esterno in pse
- 4_ rivestimento laterale
- 5_ top
- 6_ colonna di scarico (lunghezza cavo 57,5 cm)
- 7_ eventuale allacciamento da troppo pieno (ETP)
- 8_ sifone Ø 40 mm
- 9_ massetto ribassato per allacciamenti H.90 mm

technical information

- basin in cast acrylic thk. 4mm
- body in EPS density: 30 da N/mc
- internal capacity: 160 lt
- pannelling makro thk. 6mm
- idrolook: motor standard on right
- mains voltage: 220V
- blower voltage: 24V
- blower power: 220W
- colour therapy: 40W

- 1_ basin in cast acrylic
- 2_ expanded polystyrene structure (EPS)
- 3_ external polystyrene panel
- 4_ pannelling
- 5_ top
- 6_ drain column (cable length 1.57,5 cm)
- 7_ possibility to connect to deck-mounted tapware
- 8_ siphon Ø 40 mm
- 9_ lowered floor slab for connections H.90 mm

datos técnicos

- pila de acrilico colado de 4 mm de espesor
- cuerpo de EPS densidad 30 N/mc
- capacidad interna: 160 lt
- revestimiento sp.: 6mm
- idrolook: motor de serie a la derecha
- tensión de red: 220V
- tensión sopiante: 24V
- potencia sopiante: 220W
- potencia cromoterapia: 40W

- 1_ pila de acrilico colado
- 2_ estructura de polistireno densidad (EPS)
- 3_ panel externo de polistireno expandido (EPS)
- 4_ revestimiento
- 5_ encimera
- 6_ columna de desagüe (longitud cable 57,5 cm)
- 7_ posible conexión suministro borde bañera
- 8_ sifón Ø 40mm
- 9_ bloque rebajado para conexiones H.90 mm

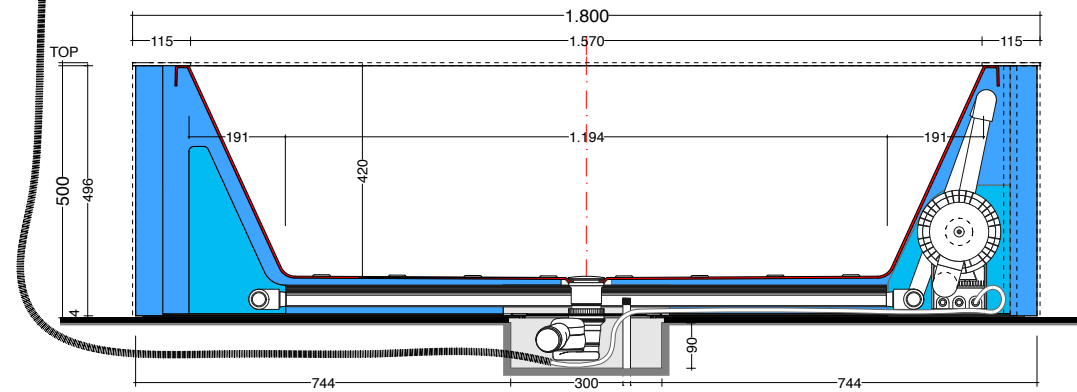
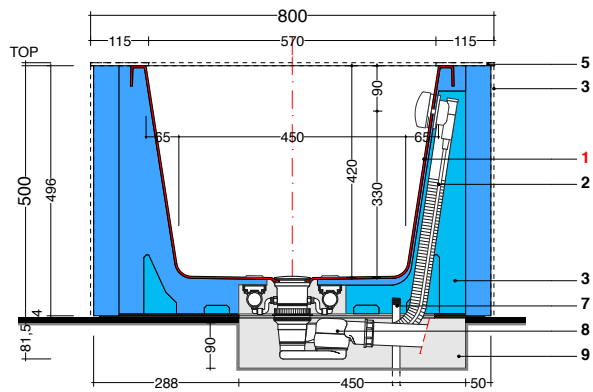
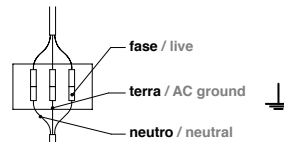
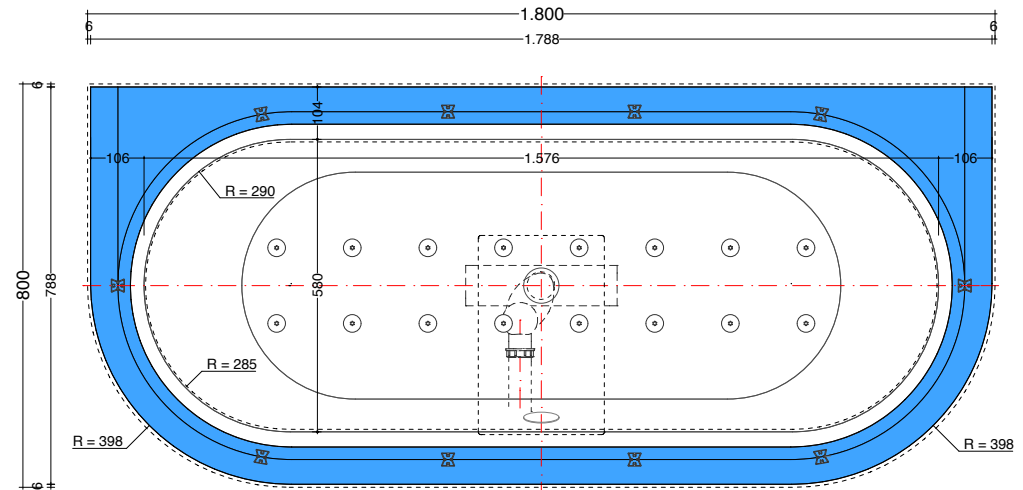

**look circle isola 180x80 _ rivestita / non rivestita
panelled / unclad
revestida / no revestida
verkleidet / unverkleidet**

idrolook

colorlook

**scheda tecnica
technical datashett
tarjeta técnica
technisches Datenblatt**

L.SQ_180.080_ / L.SQ_180.080.00

L.IDB.000.000.00

L.CLB.000.000.00

dati tecnici

- bacino in acrilico colato sp.4mm
 - corpo in EPS densità: 30 da N/mc
 - capacità interna: 160 lt
 - rivestimento laterale makro sp.: 6mm
 - idrolook: motore di serie a destra
 - tensione di rete: 220V
 - tensione soffiante: 24V
 - potenza soffiante 220W
 - potenza cromoterapia: 40W
- 1_ bacino in acrilico colato
 - 2_ struttura in polistirene espanso (PSE)
 - 3_ pannello esterno in pse
 - 4_ rivestimento laterale
 - 5_ top
 - 6_ colonna di scarico (lunghezza cavo 57,5 cm)
 - 7_ eventuale allacciamento da troppo pieno (ETP)
 - 8_ sifone Ø 40 mm
 - 9_ massetto ribassato per allacciamenti H.90 mm

technical information

- basin in cast acrylic thk. 4mm
 - body in EPS density: 30 da N/mc
 - internal capacity: 160 lt
 - panneling makro thk. 6mm
 - idrolook: motor standard on right
 - mains voltage: 220V
 - blower voltage: 24V
 - blower power: 220W
 - colour therapy: 40W
- 1_ basin in cast acrylic
 - 2_ expanded polystyrene structure (EPS)
 - 3_ external polystyrene panel
 - 4_ panneling
 - 5_ top
 - 6_ drain column (cable length 1.57,5 cm)
 - 7_ possibility to connect to deck-mounted tapware
 - 8_ siphon Ø 40 mm
 - 9_ lowered floor slab for connections H.90 mm

datos técnicos

- pila de acrilico colado de 4 mm de espesor
 - cuerpo de EPS densidad 30 N/mc
 - capacidad interna: 160 lt
 - revestimiento sp.: 6mm
 - idrolook: motor de serie a la derecha
 - tensión de red: 220V
 - tensión soplante: 24V
 - potencia soplante: 220W
 - potencia cromoterapia: 40W
- 1_ pila de acrilico colado
 - 2_ estructura de polistireno densidad (EPS)
 - 3_ panel externo de polistireno expandido (EPS)
 - 4_ revestimiento
 - 5_ encimera
 - 6_ columna de desagüe (longitud cable 57,5 cm)
 - 7_ posible conexión suministro borde bañera
 - 8_ sifón Ø 40mm
 - 9_ bloque rebajado para conexiones H.90 mm

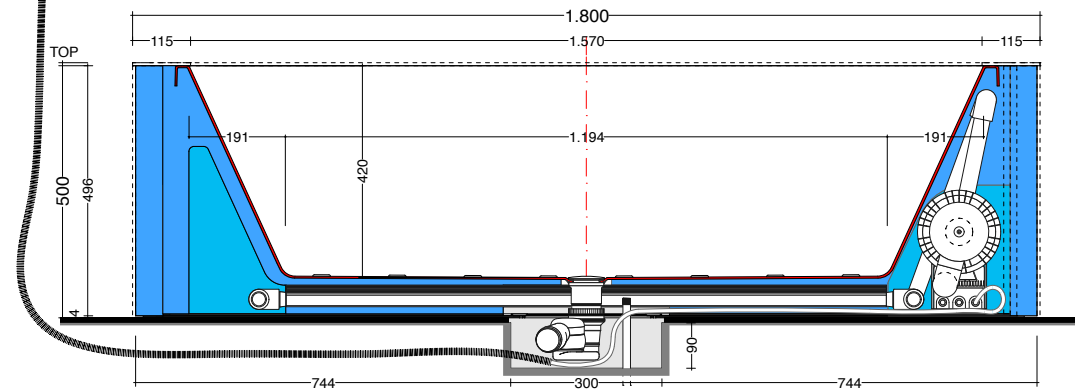
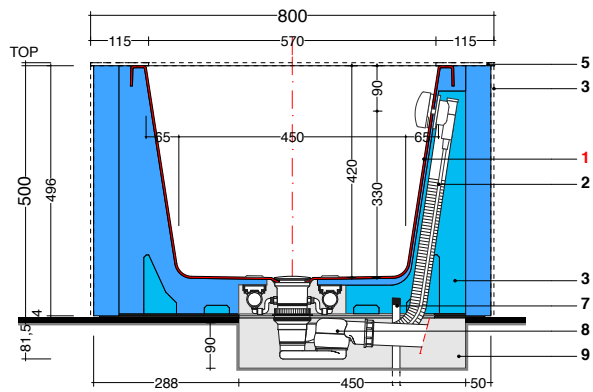
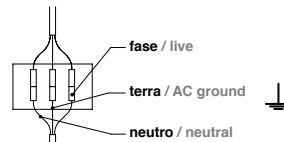
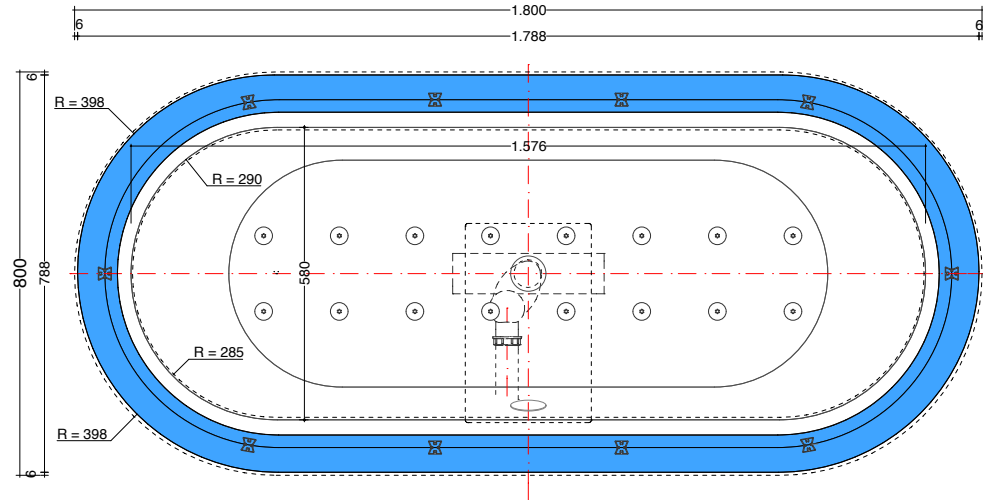

**look penisola 180x80 _ rivestita / non rivestita
panelled / unclad
revestida / no revestida
verkleidet / unverkleidet**

idrolook

colorlook

**scheda tecnica
technical datashett
tarjeta técnica
technisches Datenblatt**

L.SQ_180.080_ / L.SQ_180.080.00

L.IDB.000.000.00

L.CLB.000.000.00

dati tecnici

- bacino in acrilico colato sp.4mm
 - corpo in EPS densità: 30 da N/mc
 - capacità interna: 160 lt
 - rivestimento laterale makro sp.: 6mm
 - idrolook: motore di serie a destra
 - tensione di rete: 220V
 - tensione soffiante: 24V
 - potenza soffiante 220W
 - potenza cromoterapia: 40W
- 1_ bacino in acrilico colato
 - 2_ struttura in polistirene espanso (PSE)
 - 3_ pannello esterno in pse
 - 4_ rivestimento laterale
 - 5_ top
 - 6_ colonna di scarico (lunghezza cavo 57,5 cm)
 - 7_ eventuale allacciamento da troppo pieno (ETP)
 - 8_ sifone Ø 40 mm
 - 9_ massetto ribassato per allacciamenti H.90 mm

technical information

- basin in cast acrylic thk. 4mm
 - body in EPS density: 30 da N/mc
 - internal capacity: 160 lt
 - panneling makro thk. 6mm
 - idrolook: motor standard on right
 - mains voltage: 220V
 - blower voltage: 24V
 - blower power: 220W
 - colour therapy: 40W
- 1_ basin in cast acrylic
 - 2_ expanded polystyrene structure (EPS)
 - 3_ external polystyrene panel
 - 4_ panneling
 - 5_ top
 - 6_ drain column (cable length 1.57,5 cm)
 - 7_ possibility to connect to deck-mounted tapware
 - 8_ siphon Ø 40 mm
 - 9_ lowered floor slab for connections H.90 mm

datos técnicos

- pila de acrilico colado de 4 mm de espesor
 - cuerpo de EPS densidad 30 N/mc
 - capacidad interna: 160 lt
 - revestimiento sp.: 6mm
 - idrolook: motor de serie a la derecha
 - tensión de red: 220V
 - tensión soplante: 24V
 - potencia soplante: 220W
 - potencia cromoterapia: 40W
- 1_ pila de acrilico colado
 - 2_ estructura de polistireno densidad (EPS)
 - 3_ panel externo de polistireno expandido (EPS)
 - 4_ revestimiento
 - 5_ encimera
 - 6_ columna de desagüe (longitud cable 57,5 cm)
 - 7_ posible conexión suministro borde bañera
 - 8_ sifón Ø 40mm
 - 9_ bloque rebajado para conexiones H.90 mm

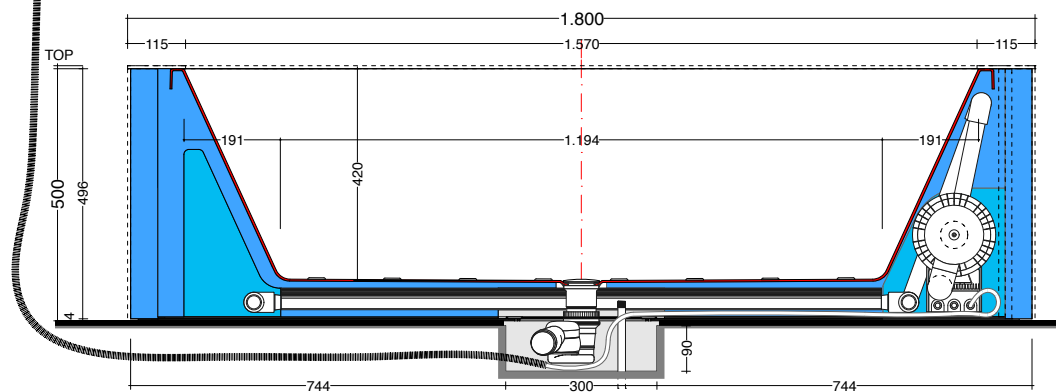
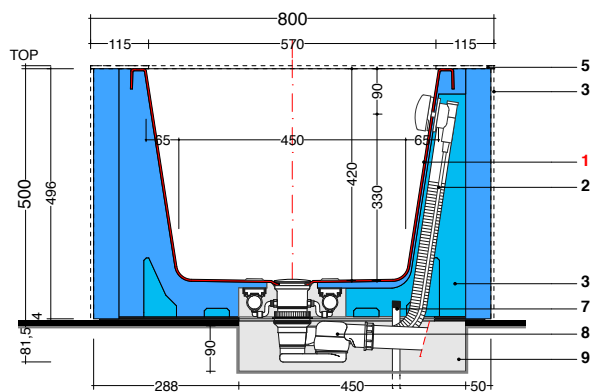
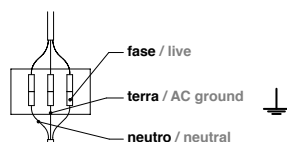
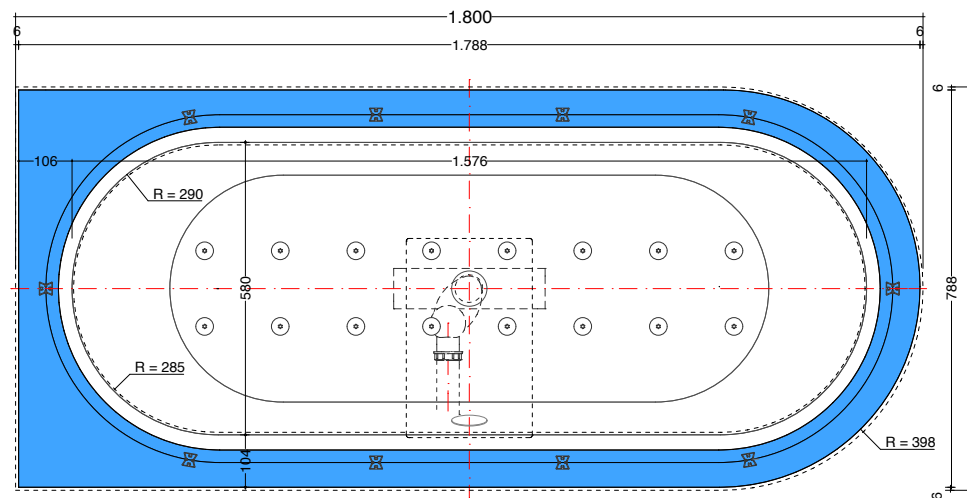

look plus ang dx 180x90 _ rivestita / non rivestita
panelled / unclad
revestida / no revestida
verkleidet / unverkleidet

idrolook

colorlook

scheda tecnica
 technical datashett
 tarjeta técnica
 technisches Datenblatt

L.SQ_180.080_ / L.SQ_180.080.00

L.IDB.000.000.00

L.CLB.000.000.00

dati tecnici

- bacino in acrilico colato sp.4mm
 - corpo in EPS densità: 30 da N/mc
 - capacità interna: 160 lt
 - rivestimento laterale makro sp.: 6mm
 - idrolook: motore di serie a destra
 - tensione di rete: 220V
 - tensione soffiante: 24V
 - potenza soffiante 220W
 - potenza cromoterapia: 40W
- 1_ bacino in acrilico colato
 - 2_ struttura in polistireno espanso (PSE)
 - 3_ pannello esterno in pse
 - 4_ rivestimento laterale
 - 5_ top
 - 6_ colonna di scarico (lunghezza cavo 57,5 cm)
 - 7_ eventuale allacciamento da troppo pieno (ETP)
 - 8_ sifone Ø 40 mm
 - 9_ massetto ribassato per allacciamenti H.90 mm

technical information

- basin in cast acrylic thk. 4mm
 - body in EPS density: 30 da N/mc
 - internal capacity: 160 lt
 - pannelling makro thk. 6mm
 - idrolook: motor standard on right
 - mains voltage: 220V
 - blower voltage: 24V
 - blower power: 220W
 - colour therapy: 40W
- 1_ basin in cast acrylic
 - 2_ expanded polystyrene structure (EPS)
 - 3_ external polystyrene panel
 - 4_ pannelling
 - 5_ top
 - 6_ drain column (cable length 1.57,5 cm)
 - 7_ possibility to connect to deck-mounted tapware
 - 8_ siphon Ø 40 mm
 - 9_ lowered floor slab for connections H.90 mm

datos técnicos

- pila de acrilico colado de 4 mm de espesor
 - cuerpo de EPS densidad 30 N/mc
 - capacidad interna: 160 lt
 - revestimiento sp.: 6mm
 - idrolook: motor de serie a la derecha
 - tensión de red: 220V
 - tensión soplante: 24V
 - potencia soplante: 220W
 - potencia cromoterapia: 40W
- 1_ pila de acrilico colado
 - 2_ estructura de polistireno densidad (EPS)
 - 3_ panel externo de polistireno expandido (EPS)
 - 4_ revestimiento
 - 5_ encimera
 - 6_ columna de desagüe (longitud cable 57,5 cm)
 - 7_ posible conexión suministro borde bañera
 - 8_ sifón Ø 40mm
 - 9_ bloque rebajado para conexiones H.90 mm

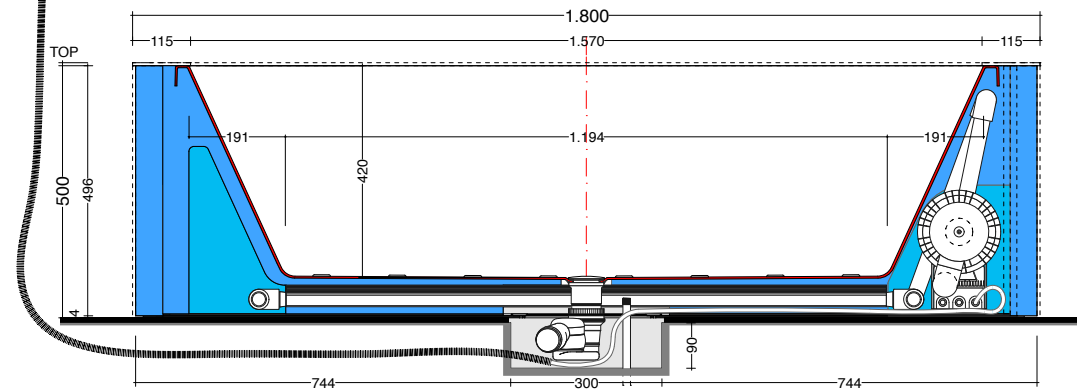
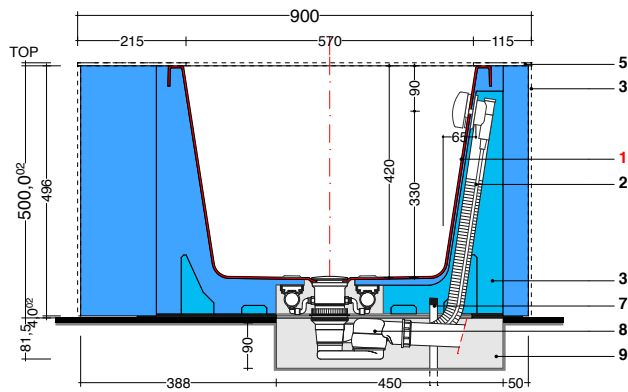
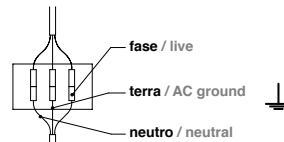
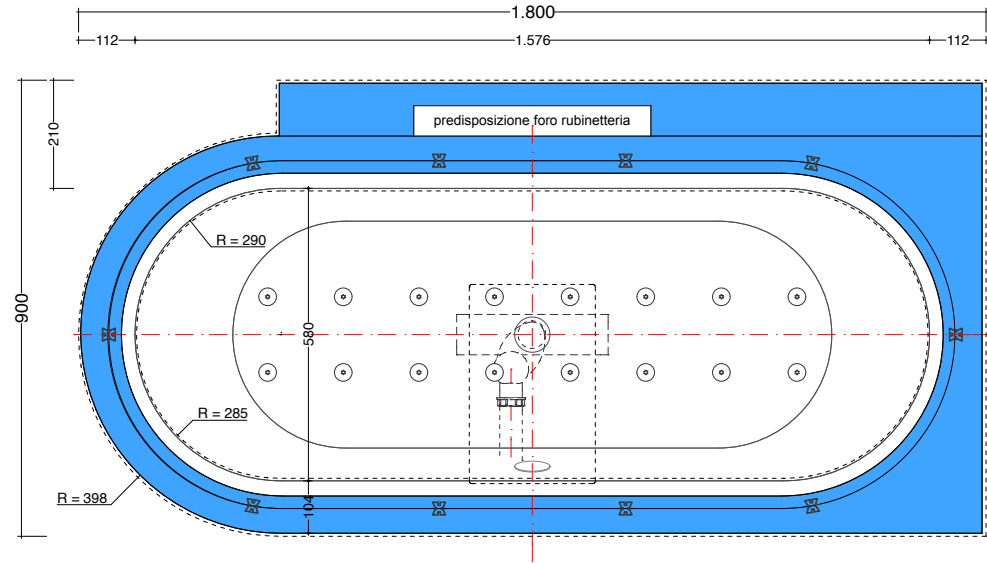

look plus ang sx 180x90 _ rivestita / non rivestita
panelled / unclad
revestida / no revestida
verkleidet / unverkleidet

idrolook

colorlook

scheda tecnica
 technical datashett
 tarjeta técnica
 technisches Datenblatt

L.SQ_180.080_ / L.SQ_180.080.00

L.IDB.000.000.00

L.CLB.000.000.00

dati tecnici

- bacino in acrilico colato sp.4mm
 - corpo in EPS densità: 30 da N/mc
 - capacità interna: 160 lt
 - rivestimento laterale makro sp.: 6mm
 - idrolook: motore di serie a destra
 - tensione di rete: 220V
 - tensione soffiante: 24V
 - potenza soffiante 220W
 - potenza cromoterapia: 40W
- 1_ bacino in acrilico colato
 - 2_ struttura in polistireno espanso (PSE)
 - 3_ pannello esterno in pse
 - 4_ rivestimento laterale
 - 5_ top
 - 6_ colonna di scarico (lunghezza cavo 57,5 cm)
 - 7_ eventuale allacciamento da troppo pieno (ETP)
 - 8_ sifone Ø 40 mm
 - 9_ massetto ribassato per allacciamenti H.90 mm

technical information

- basin in cast acrylic thk. 4mm
 - body in EPS density: 30 da N/mc
 - internal capacity: 160 lt
 - panneling makro thk. 6mm
 - idrolook: motor standard on right
 - mains voltage: 220V
 - blower voltage: 24V
 - blower power: 220W
 - colour therapy: 40W
- 1_ basin in cast acrylic
 - 2_ expanded polystyrene structure (EPS)
 - 3_ external polystyrene panel
 - 4_ panneling
 - 5_ top
 - 6_ drain column (cable length 1.57,5 cm)
 - 7_ possibility to connect to deck-mounted tapware
 - 8_ siphon Ø 40 mm
 - 9_ lowered floor slab for connections H.90 mm

datos técnicos

- pila de acrilico colado de 4 mm de espesor
 - cuerpo de EPS densidad 30 N/mc
 - capacidad interna: 160 lt
 - revestimiento sp.: 6mm
 - idrolook: motor de serie a la derecha
 - tensión de red: 220V
 - tensión soplante: 24V
 - potencia soplante: 220W
 - potencia cromoterapia: 40W
- 1_ pila de acrilico colado
 - 2_ estructura de polistireno densidad (EPS)
 - 3_ panel externo de polistireno expandido (EPS)
 - 4_ revestimiento
 - 5_ encimera
 - 6_ columna de desagüe (longitud cable 57,5 cm)
 - 7_ posible conexión suministro borde bañera
 - 8_ sifón Ø 40mm
 - 9_ bloque rebajado para conexiones H.90 mm

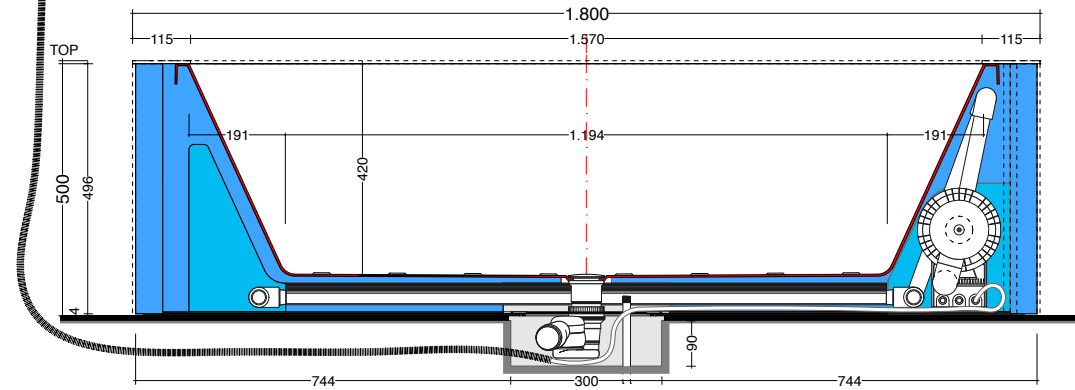
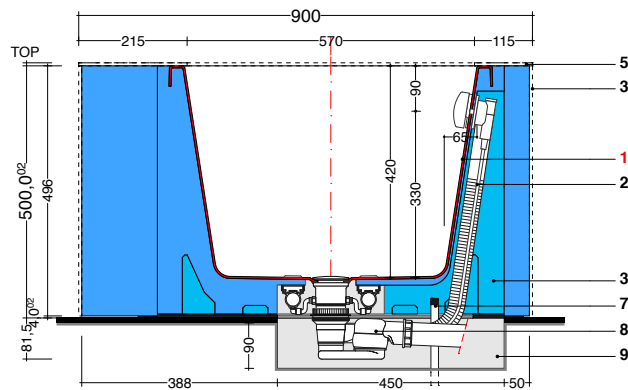
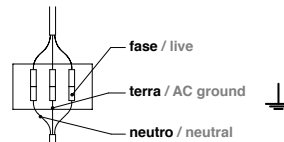
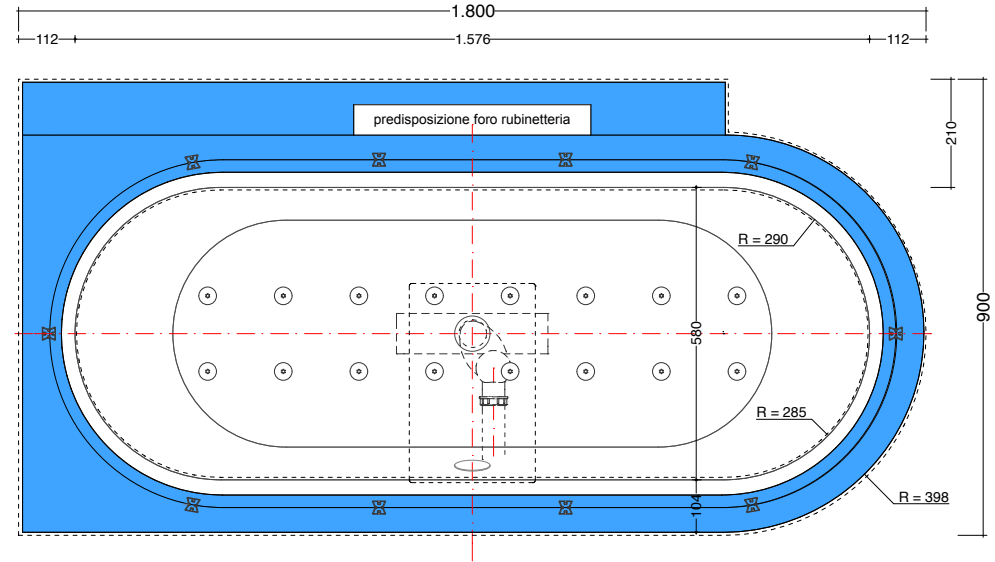

**look plus parete 180x90 _ rivestita / non rivestita
panelled / unclad
revestida / no revestida
verkleidet / unverkleidet**

idrolook

colorlook

**scheda tecnica
technical datashett
tarjeta técnica
technisches Datenblatt**

L.SQ_180.080_ / L.SQ_180.080.00

L.IDB.000.000.00

L.CLB.000.000.00

dati tecnici

- bacino in acrilico colato sp.4mm
 - corpo in EPS densità: 30 da N/mc
 - capacità interna: 160 lt
 - rivestimento laterale makro sp.: 6mm
 - idrolook: motore di serie a destra
 - tensione di rete: 220V
 - tensione soffiante: 24V
 - potenza soffiante 220W
 - potenza cromoterapia: 40W
- 1_ bacino in acrilico colato
 - 2_ struttura in polistirene espanso (PSE)
 - 3_ pannello esterno in pse
 - 4_ rivestimento laterale
 - 5_ top
 - 6_ colonna di scarico (lunghezza cavo 57,5 cm)
 - 7_ eventuale allacciamento da troppo pieno (ETP)
 - 8_ sifone Ø 40 mm
 - 9_ massetto ribassato per allacciamenti H.90 mm

technical information

- basin in cast acrylic thk. 4mm
 - body in EPS density: 30 da N/mc
 - internal capacity: 160 lt
 - panneling makro thk. 6mm
 - idrolook: motor standard on right
 - mains voltage: 220V
 - blower voltage: 24V
 - blower power: 220W
 - colour therapy: 40W
- 1_ basin in cast acrylic
 - 2_ expanded polystyrene structure (EPS)
 - 3_ external polystyrene panel
 - 4_ panneling
 - 5_ top
 - 6_ drain column (cable length 1.57,5 cm)
 - 7_ possibility to connect to deck-mounted tapware
 - 8_ siphon Ø 40 mm
 - 9_ lowered floor slab for connections H.90 mm

datos técnicos

- pila de acrilico colado de 4 mm de espesor
 - cuerpo de EPS densidad 30 N/mc
 - capacidad interna: 160 lt
 - revestimiento sp.: 6mm
 - idrolook: motor de serie a la derecha
 - tensión de red: 220V
 - tensión soplante: 24V
 - potencia soplante: 220W
 - potencia cromoterapia: 40W
- 1_ pila de acrilico colado
 - 2_ estructura de polistireno densidad (EPS)
 - 3_ panel externo de polistireno expandido (EPS)
 - 4_ revestimiento
 - 5_ encimera
 - 6_ columna de desagüe (longitud cable 57,5 cm)
 - 7_ posible conexión suministro borde bañera
 - 8_ sifón Ø 40mm
 - 9_ bloque rebajado para conexiones H.90 mm

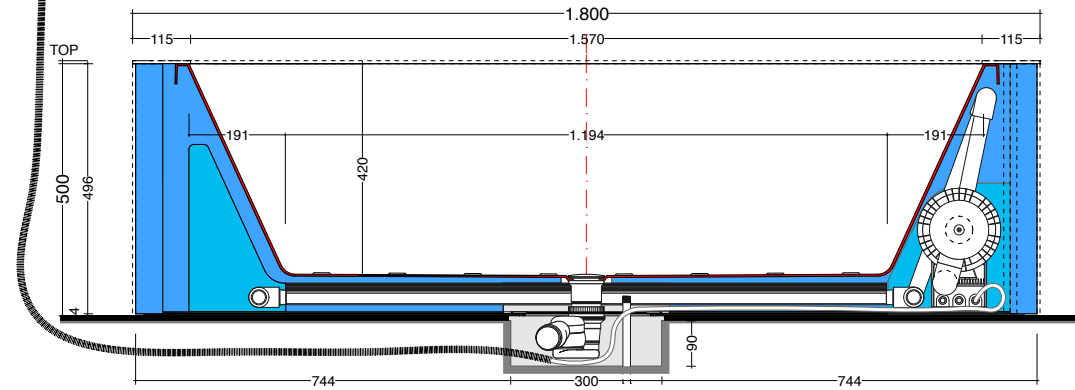
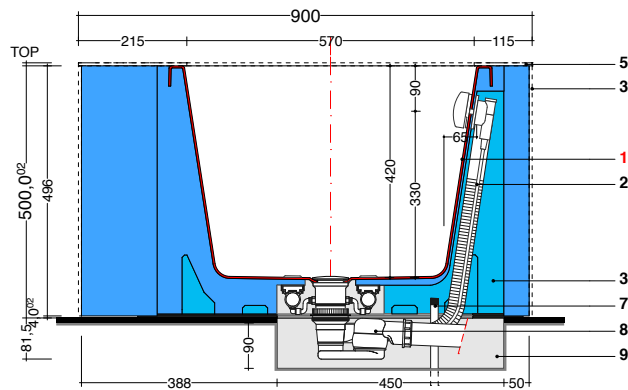
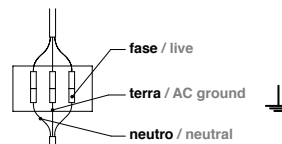
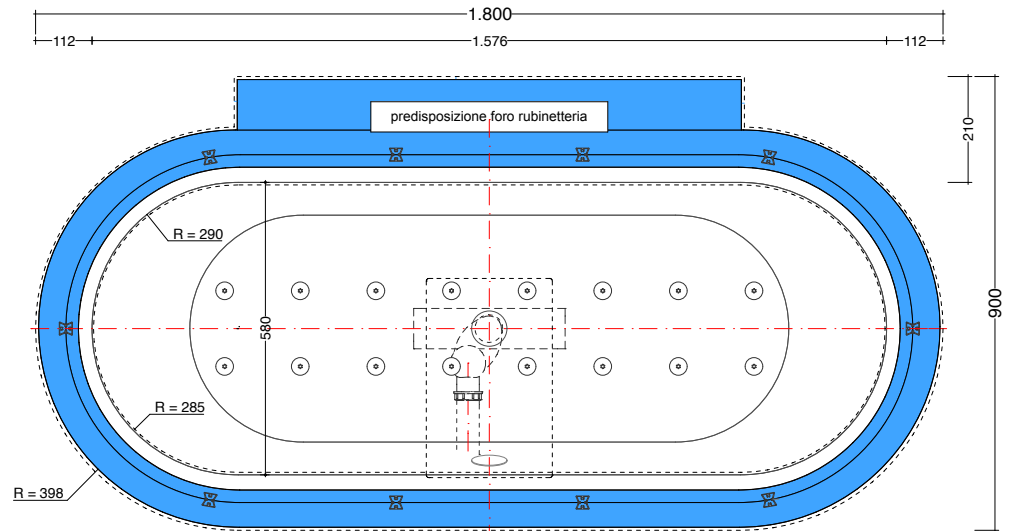

look city 150x150 _

**rivestita / non rivestita
panelled / unclad
revestida / no revestida
verkleidet / unverkleidet**

idrolook

colorlook

scheda tecnica
technical datashett
tarjeta técnica
technisches Datenblatt

L.SQ_180.080_ / L.SQ_180.080.00

L.IDB.000.000.00

L.CLB.000.000.00

dati tecnici

- bacino in acrilico colato sp.4mm
 - corpo in EPS densità: 30 da N/mc
 - capacità interna: 160 lt
 - rivestimento laterale makro sp.: 6mm
 - idrolook: motore di serie a destra
 - tensione di rete: 220V
 - tensione soffiante: 24V
 - potenza soffiante 220W
 - potenza cromoterapia: 40W
- 1_ bacino in acrilico colato
 - 2_ struttura in polistirene espanso (PSE)
 - 3_ pannello esterno in pse
 - 4_ rivestimento laterale
 - 5_ top
 - 6_ colonna di scarico (lunghezza cavo 57,5 cm)
 - 7_ eventuale allacciamento da troppo pieno (ETP)
 - 8_ sifone Ø 40 mm
 - 9_ massetto ribassato per allacciamenti H.90 mm

technical information

- basin in cast acrylic thk. 4mm
 - body in EPS density: 30 da N/mc
 - internal capacity: 160 lt
 - panneling makro thk. 6mm
 - idrolook: motor standard on right
 - mains voltage: 220V
 - blower voltage: 24V
 - blower power: 220W
 - colour therapy: 40W
- 1_ basin in cast acrylic
 - 2_ expanded polystyrene structure (EPS)
 - 3_ external polystyrene panel
 - 4_ panneling
 - 5_ top
 - 6_ drain column (cable length 1.57,5 cm)
 - 7_ possibility to connect to deck-mounted tapware
 - 8_ siphon Ø 40 mm
 - 9_ lowered floor slab for connections H.90 mm

datos técnicos

- pila de acrilico colado de 4 mm de espesor
 - cuerpo de EPS densidad 30 N/mc
 - capacidad interna: 160 lt
 - revestimiento sp.: 6mm
 - idrolook: motor de serie a la derecha
 - tensión de red: 220V
 - tensión soplante: 24V
 - potencia soplante: 220W
 - potencia cromoterapia: 40W
- 1_ pila de acrilico colado
 - 2_ estructura de polistireno densidad (EPS)
 - 3_ panel externo de polistireno expandido (EPS)
 - 4_ revestimiento
 - 5_ encimera
 - 6_ columna de desagüe (longitud cable 57,5 cm)
 - 7_ posible conexión suministro borde bañera
 - 8_ sifón Ø 40mm
 - 9_ bloque rebajado para conexiones H.90 mm

