

AVAS0910 "NORMAL" Vasca in "Cristalplant®" / Bathtub in "Cristalplant®"

area posizionamento scarico
area for position of waste pipe

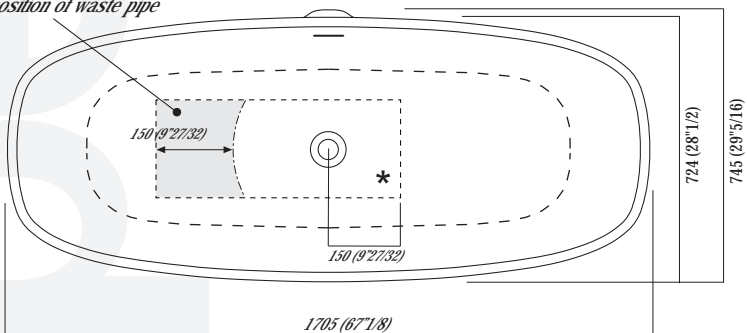

La vasca "Normal" deve essere installata su un pavimento perfettamente piano.
E' necessario predisporre a pavimento un pozzetto.
The "Normal" bath tub must be positioned on a flat floor surface.
It is necessary to prepare a recess in floor surface.

Se si prevede l'utilizzo del pozzetto AKITPZVAS
attenersi alle istruzioni allegate.

When using the recess AKITPZVAS please follow
the instructions attached.

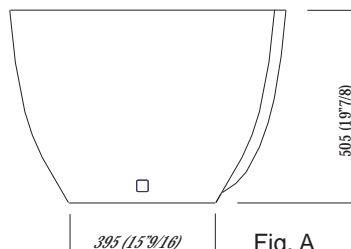
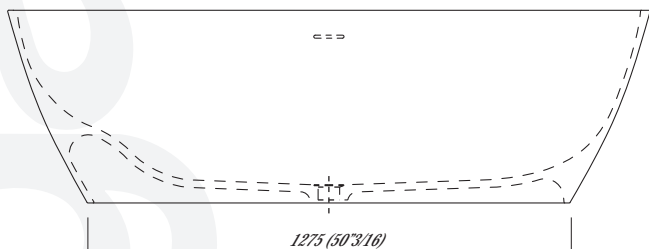
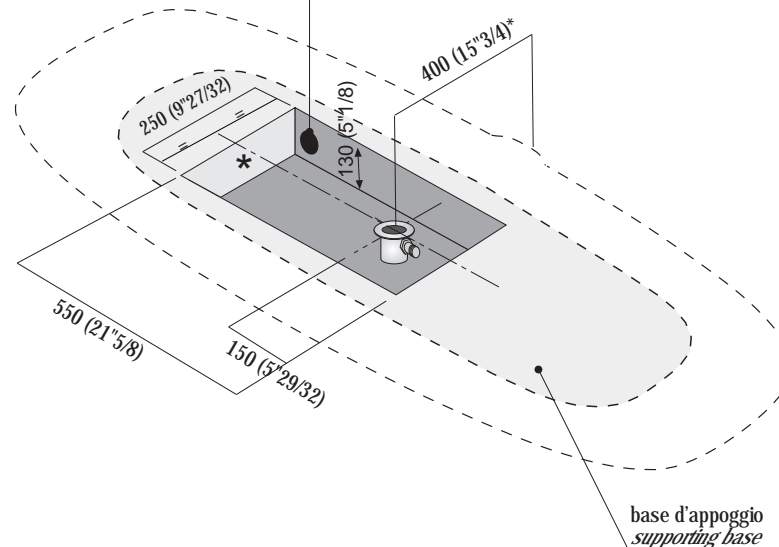

Fig. A

La vasca "Normal" deve essere installata su un pavimento perfettamente piano.
E' necessario predisporre a pavimento un pozzetto
N.B. Evitare di realizzare impianti di riscaldamento nell'area sottostante la vasca.
The "Normal" bath tub must be positioned on a flat floor surface.
It is necessary to prepare a recess in the floor.
Note: Avoid the installation of floor heating plan stin the area under the bathtub.

tubo di scarico Ø40 mm con OR di tenuta.
mm 40 Ø (1'5/8) drain pipe with a OR gasket.



area posizionamento scarico
area for position of waste pipe

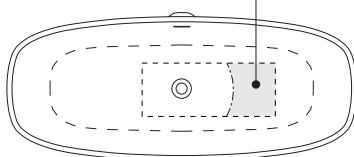

Il pozzetto si può orientare anche nell'altro senso
The recess can be orientated to the other side too.

Quote in millimetri
Dimensions are expressed in mm.

AVAS0910 "NORMAL" Vasca in "Cristalplant®" / Bathtub in "Cristalplant®"

RUBINETTERIA A PARETE / WALL MOUNTED TAPS

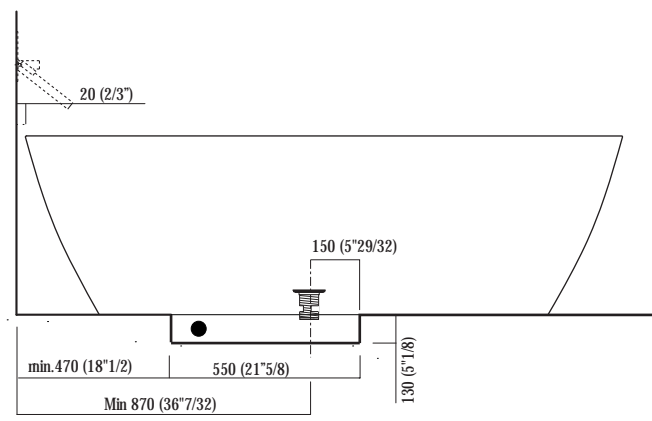
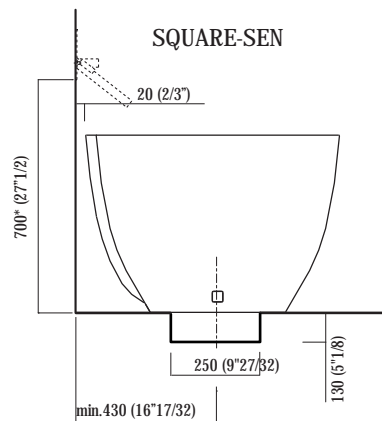
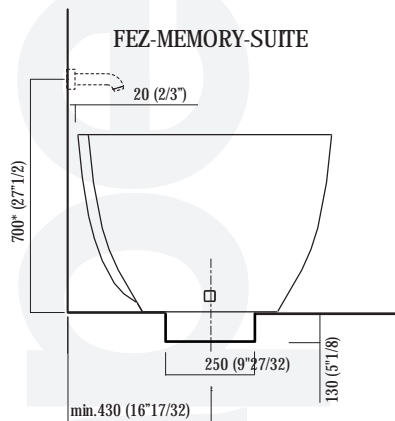

FEZ: ARUB050000L, ARUB051000L, ARUB150000C,
ARUB151000C, ARUB190000C, ARUB1910000C
SQUARE: ARUB932N, ARUB933N
SEN: ASEN912V
MEMORY: ARUB1076, ARUB1089, ARUB1077,
ARUB1040, ARUB1091.
SUITE: ARUB1107

* h. consigliata centro bocca erogazione rubinetteria Fez-Suite-Memory
* advised height centre spout tap Fez-Suite-Memory

**h. consigliata / advised h. Square-Sen

QUOTE CONSIGLIATE PER PIANTANE DA TERRA / RECOMMENDED MEASURES FOR FREESTANDING SPOUT

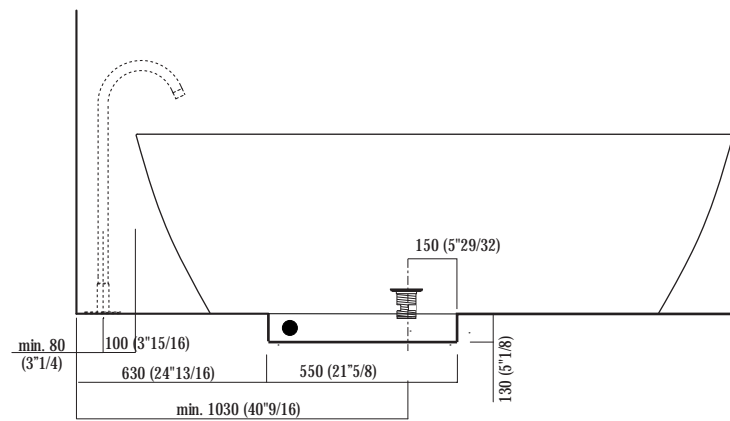
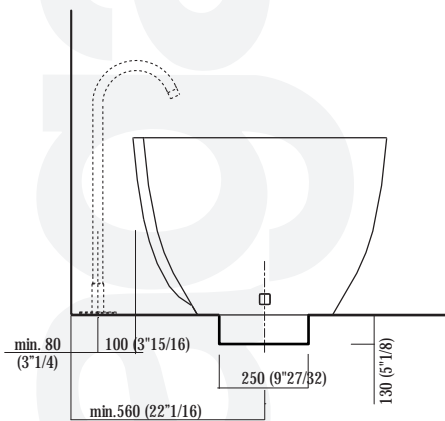

FEZ: ARUB140, ARUB145, ARUB170N
MEMORY: ARUB1078, ARUB1033
SUITE: ARUB1108

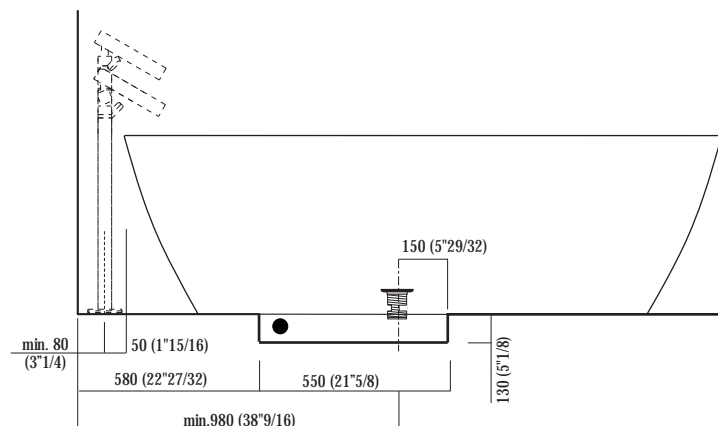
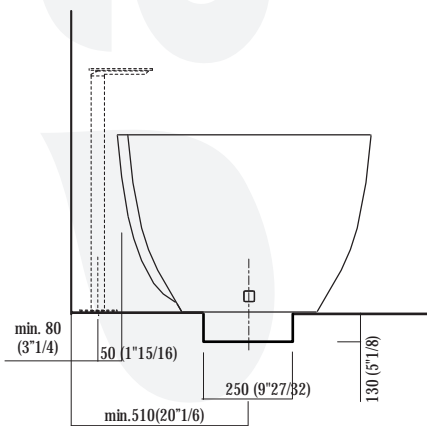

SEN: SEN911
SQUARE: RUB961L, RUB934L,
RUB935L, RUB936NL, RUB952L,

AVAS0910 "NORMAL" Vasca in "Cristalplant®" / Bathtub in "Cristalplant®"

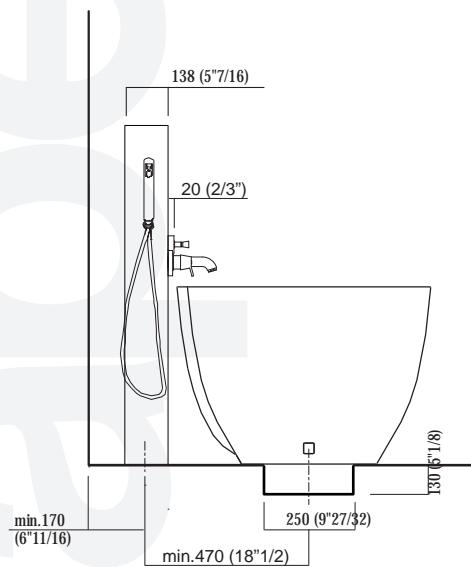

PILLAR 2 + FEZ: COL232+RUB050N

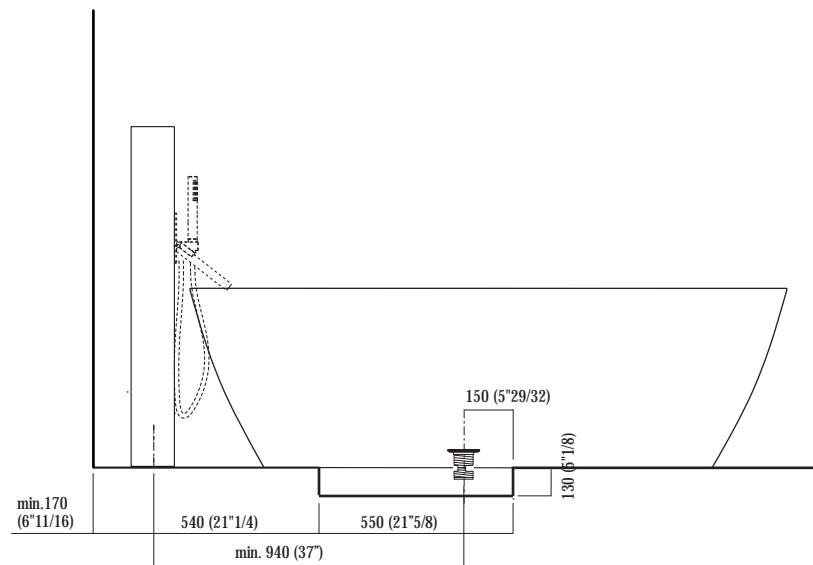

PILLAR 2 + SQUARE: COL232+RUB932N

FEZ: ARUB050000L, ARUB051000L, ARUB150000C,
ARUB151000C, ARUB190000C, ARUB1910000C
SQUARE: ARUB932N, ARUB933N
SEN: ASEN912V
MEMORY: ARUB1076, ARUB1089, ARUB1077,
ARUB1040, ARUB1091.
SUITE: ARUB1107

AVAS0910 "NORMAL" Vasca in "Cristalplant®" / Bathtub in "Cristalplant®"

- 1 *Posizionare la vasca sugli appositi distanziatori sopra il pozzetto come indicato a pag.1. e procedere al collegamento del sifone, e della piletta.*
Position the bathtub on the proper spacers, over the recess and proceed to connect the drain trap, the waste and the overflow.

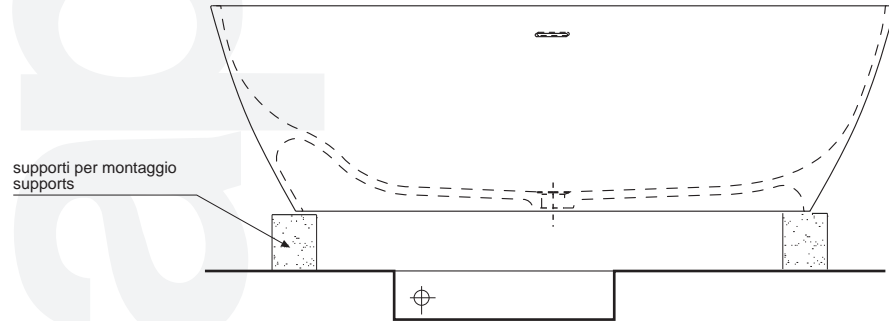

PARTICOLARE PILETTA / DRAIN DETAIL

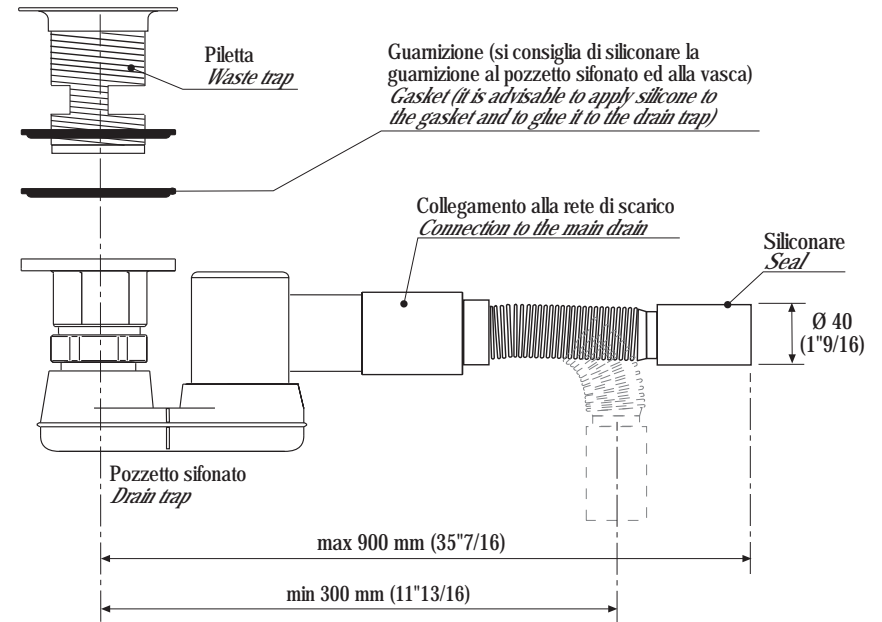

- 2 *Effettuare alcune prove di tenuta dell'impianto realizzato. Questo é reso possibile dalla posizione provvisoria data dai distanziatori in legno posti sotto alla vasca.*
Test different times the seal of the realised plant: this is possible thanks to the provisory position allowed by the wooden spacers placed under the bathtub.

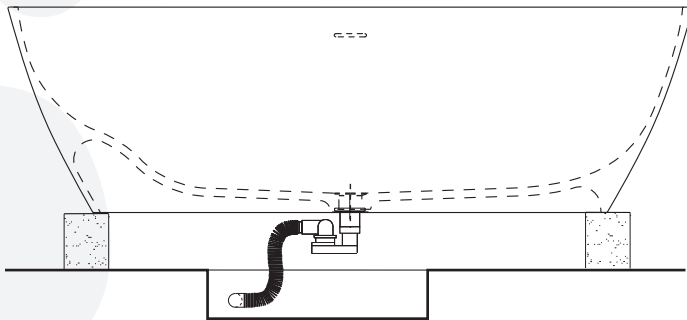

- 3 *Nel caso non si siano verificate perdite togliere i distanziatori in legno avendo cura di non effettuare movimenti bruschi o spostamenti troppo ampi.*
Posizionare a terra la vasca nel punto stabilito, quindi procedere alla siliconatura perimetrale del basamento.
If no losses are occurred, remove the wooden spacers without provoking hard movements or wide shifts.
Position the bathtub on the floor in the forecast point, then apply silicone to the base perimeter.

